

Stainless Steel

A-TYPE 3



Tested Pressure : 12 bar

Max. Temperature: 95°C

10 years warranty

Material : Stainless Steel 304 

Connection : Wall connection G1/2"

Construction : 150x50x1,5 mm  30x50x1,5 mm  Ø25x3 mm 

Package contents

Assembly parts

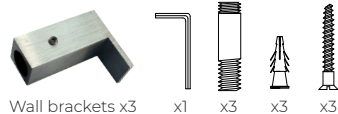

Air vent x1

Air vent cap x1



 inlet/outlet

 air vent

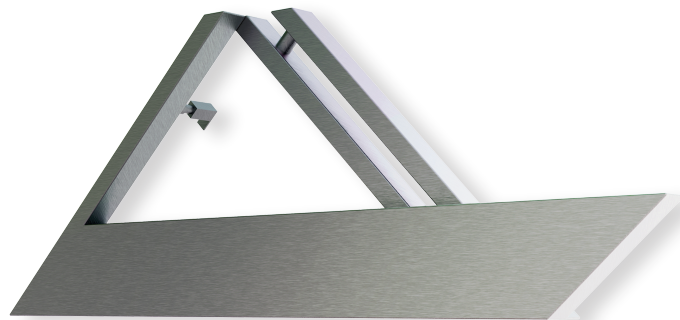
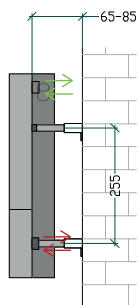
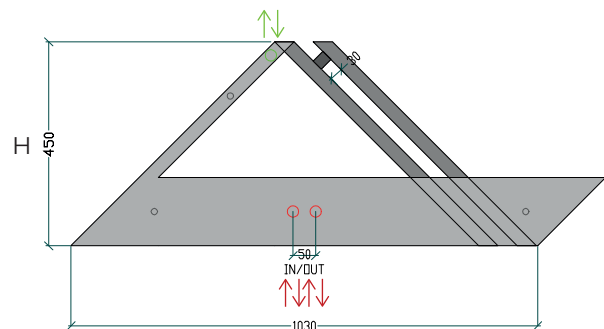
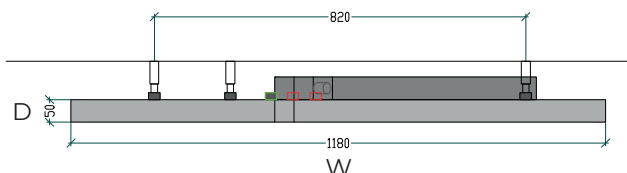

Model Code	Height (H) mm	Width (W) mm	Depth (D) mm	Slice Quantity	Pipe Centers mm	Heat Output ΔT 50°C	
						Watt	Btu
A-Type 3	450	1150	100	3	80	176	599

*Can be manufactured in all sizes & slice quantities

*Dimension and position of pipe centers can be customized